

## TECHNICAL SPECIFICATIONS

# Industrial Granulator ZX14



### General characteristics:

- Type: ZX14
- Crushing Chamber: 1400x650 mm
- Rotor Knives: 15 pcs
- Stationary Knives: 4 pcs
- Knife Material: Cr12MoV
- Motor Power: 90-110 kW
- Rotor Diameter: 650 mm
- Capacity: 1500-2000 kg/h
- Chamber Opening: Electric

### Knives:

- Tempered steel type Cr12MoV for stationary and rotor knives.
- Heat-treated to 60 HRC.
- All surfaces are precision grounded.

**Dimensions:**

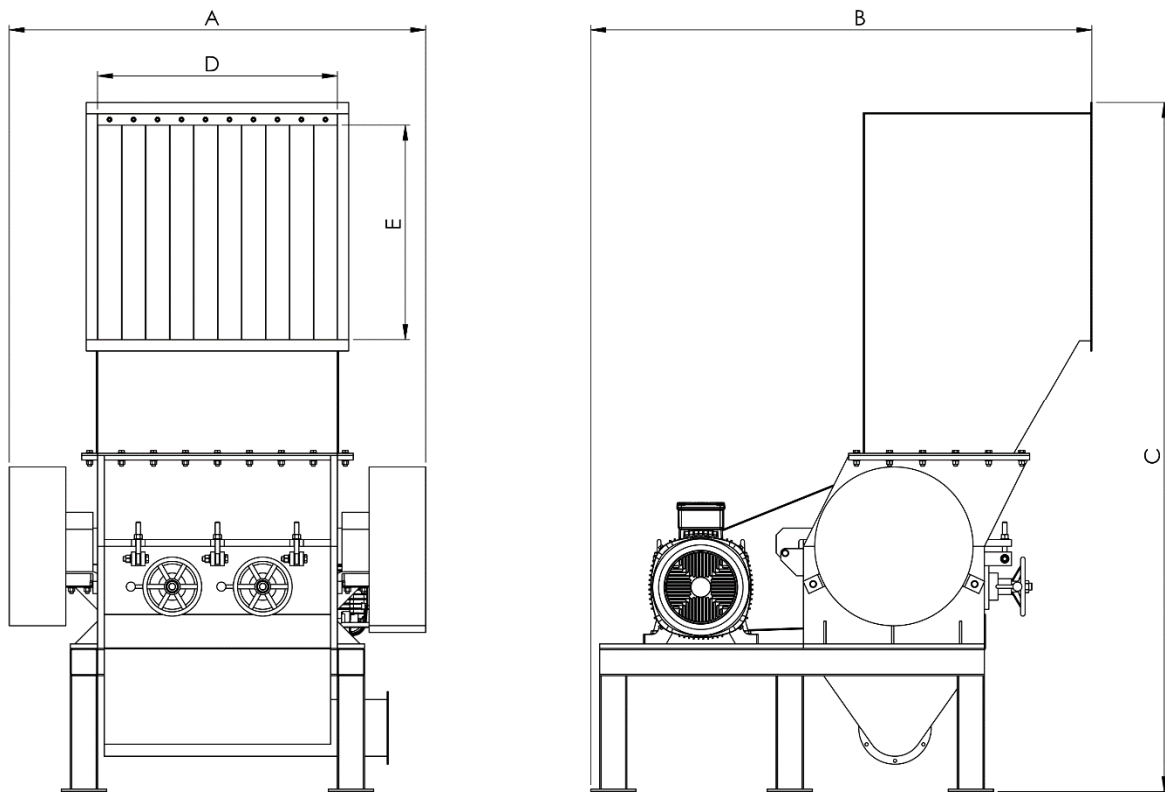

A	B	C	D	E	weight
2600 mm	2800 mm	3200 mm	1420 mm	1220 mm	6800 kg