

TECHNICAL SPECIFICATIONS

Movable Granulator ZM3



General characteristics:

- Type: ZM3
- Crushing Chamber: 310x200 mm
- Rotor Knives: 9 pcs
- Stationary Knives: 2 pcs
- Knife Material: Cr12MoV
- Motor Power: 5.5 kW
- Rotor Diameter: 200 mm
- Capacity: 100-150 kg/h
- Chamber Opening: Manual

Knives:

- Tempered steel type Cr12MoV for stationary and rotor knives.
- Heat-treated to 60 HRC.
- All surfaces are precision grounded.

Dimensions:

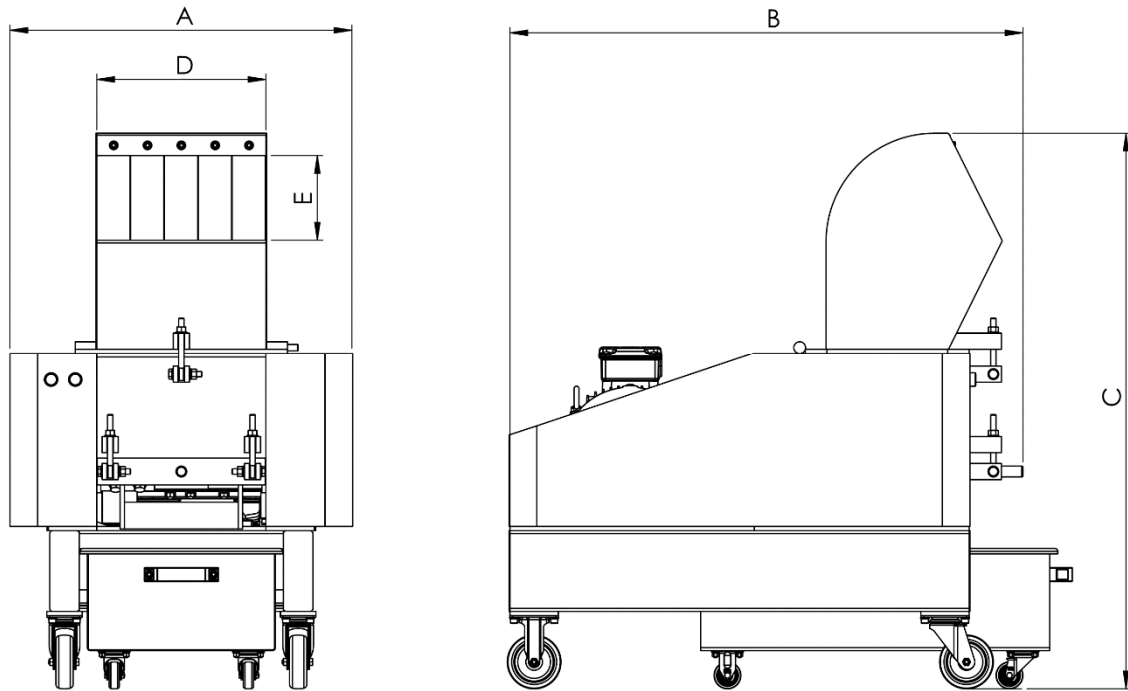

A	B	C	D	E	weight
750 mm	1100 mm	1050 mm	310 mm	300 mm	390 kg