

## TECHNICAL SPECIFICATIONS

# Movable Granulator ZM2



### General characteristics:

- Type: ZM2
- Crushing Chamber: 240x200 mm
- Rotor Knives: 9 pcs
- Stationary Knives: 2 pcs
- Knife Material: Cr12MoV
- Motor Power: 4 kW
- Rotor Diameter: 180 mm
- Capacity: 70-120 kg/h
- Chamber Opening: Manual

### Knives:

- Tempered steel type Cr12MoV for stationary and rotor knives.
- Heat-treated to 60 HRC.
- All surfaces are precision grounded.

**Dimensions:**

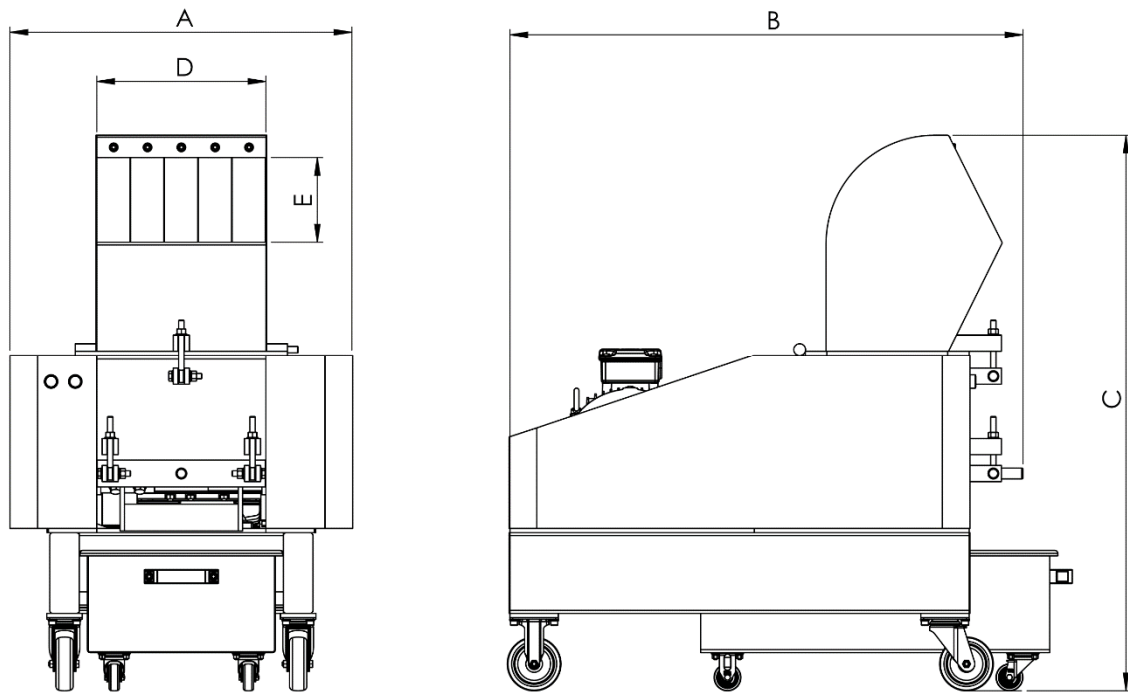

A	B	C	D	E	weight
620 mm	900 mm	1090 mm	240 mm	200 mm	280 kg