

TECHNICAL SPECIFICATIONS

Industrial Granulator ZX8



General characteristics:

- Type: ZX8
- Crushing Chamber: 800x450 mm
- Rotor Knives: 10 pcs
- Stationary Knives: 4 pcs
- Knife Material: Cr12MoV
- Motor Power: 37-45 kW
- Rotor Diameter: 450 mm
- Capacity: 400-600 kg/h
- Chamber Opening: Electric

Knives:

- Tempered steel type Cr12MoV for stationary and rotor knives.
- Heat-treated to 60 HRC.
- All surfaces are precision grounded.

Dimensions:

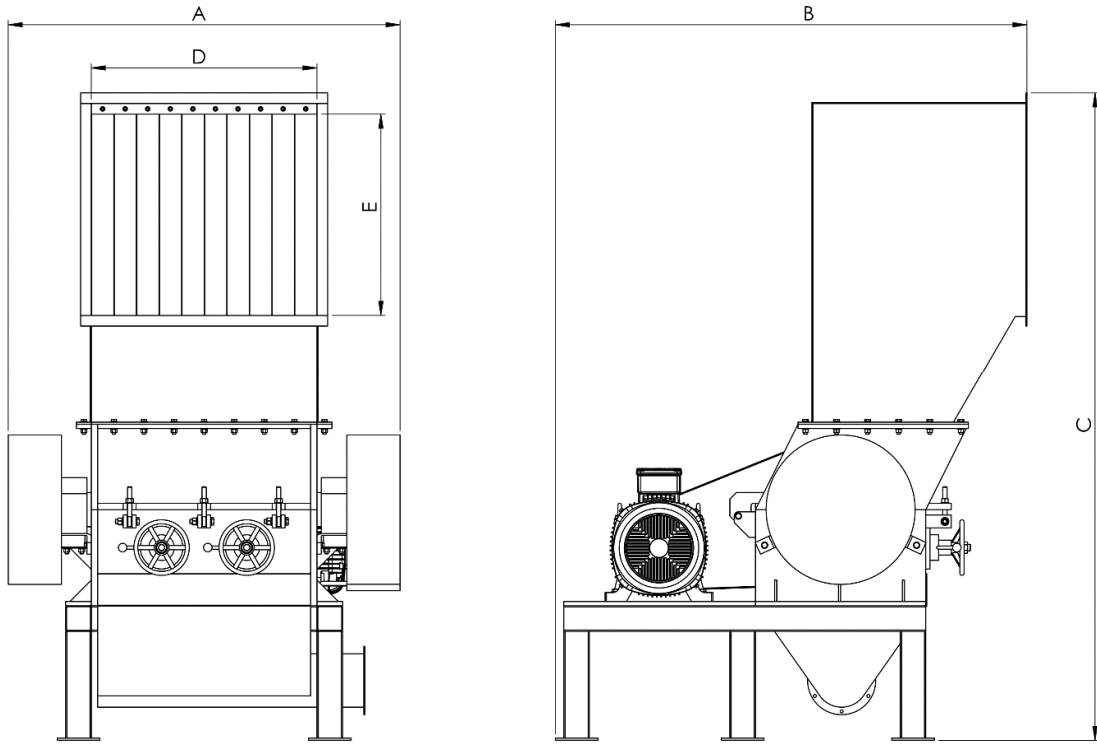

A	B	C	D	E	weight
1600 mm	1800 mm	2250 mm	820 mm	620 mm	2500 kg