

TECHNICAL SPECIFICATIONS

Industrial Granulator ZX10



General characteristics:

- Type: ZX10
- Crushing Chamber: 1000x650 mm
- Rotor Knives: 10 pcs
- Stationary Knives: 4 pcs
- Knife Material: Cr12MoV
- Motor Power: 55-75 kW
- Rotor Diameter: 650 mm
- Capacity: 500-900 kg/h
- Chamber Opening: Electric

Knives:

- Tempered steel type Cr12MoV for stationary and rotor knives.
- Heat-treated to 60 HRC.
- All surfaces are precision grounded.

Dimensions:

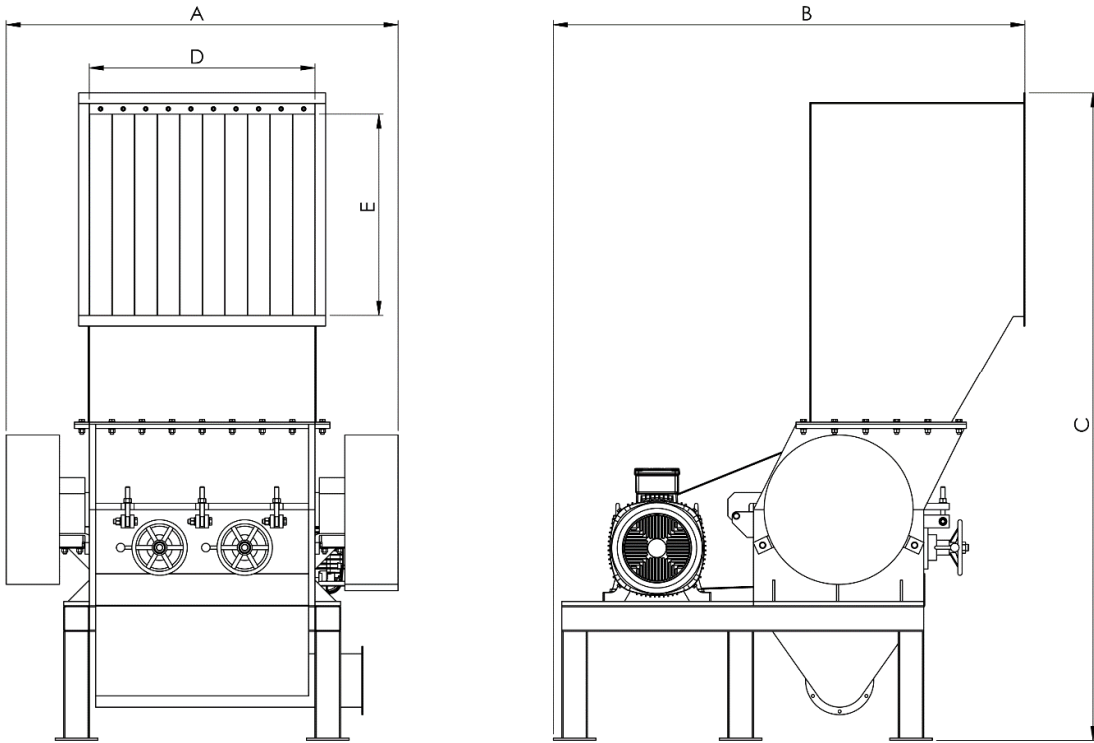

A	B	C	D	E	weight
2000 mm	2300 mm	2800 mm	1020 mm	820 mm	3800 kg