

TECHNICAL SPECIFICATIONS

Single-Shaft Shredder ZS8



General Characteristics:

- Type: ZS8
- Crushing Chamber: 960x810 mm
- Rotor Knives: 34 pcs
- Stationary Knives: 4 pcs
- Knife Material: Cr12MoV
- Motor Power: 37-45 kW
- Hydraulic Power: 3 kW
- Shaft Speed: 80 rpm
- Rotor diameter: 400 mm
- Capacity: 400-700 kg/h

Knives:

- Tempered steel type Cr12MoV for stationary and rotor knives.
- Heat-treated to 60 HRC.
- All surfaces are precision grounded.

Control System:

- PLC control

Dimensions:

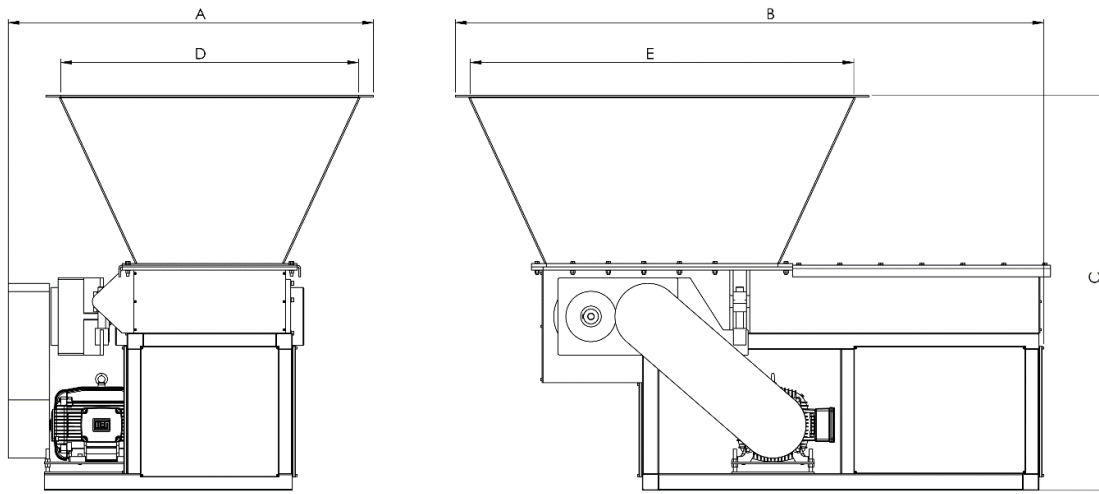

A	B	C	D	E	weight
2400 mm	2700 mm	2100 mm	1000 mm	1400 mm	3200 kg