

TECHNICAL SPECIFICATIONS

Single-Shaft Shredder ZS6



General Characteristics:

- Type: ZS6
- Crushing Chamber: 960x610 mm
- Rotor Knives: 26 pcs
- Stationary Knives: 2 pcs
- Knife Material: Cr12MoV
- Motor Power: 22-30 kW
- Hydraulic Power: 2.2 kW
- Shaft Speed: 80 rpm
- Rotor diameter: 280 mm
- Capacity: 200-400 kg/h

Knives:

- Tempered steel type Cr12MoV for stationary and rotor knives.
- Heat-treated to 60 HRC.
- All surfaces are precision grounded.

Control System:

- PLC control

Dimensions:

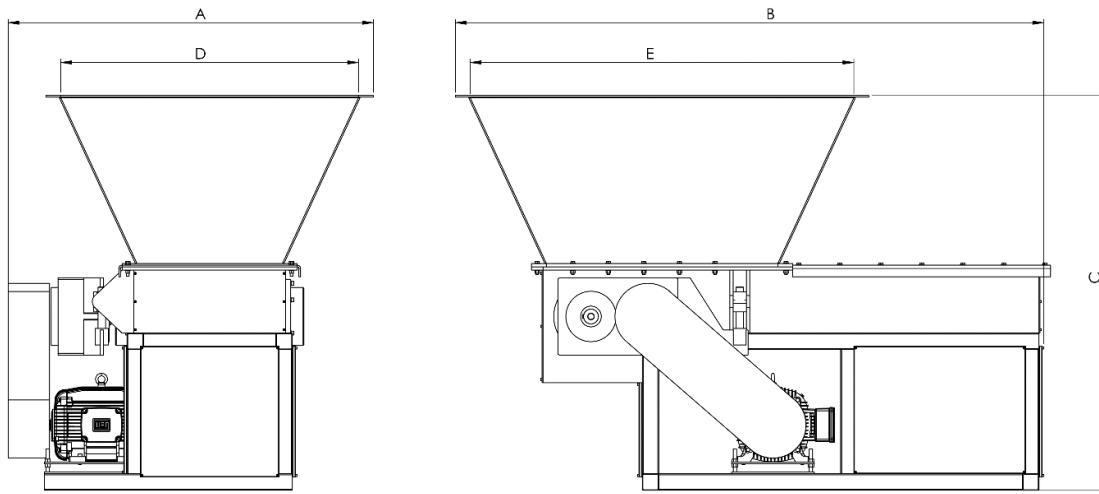

A	B	C	D	E	weight
2200 mm	2500 mm	1800 mm	800 mm	1200 mm	2100 kg