

TECHNICAL SPECIFICATIONS

Single-Shaft Shredder ZS10



General Characteristics:

- Type: ZS10
- Crushing Chamber: 960x1010 mm
- Rotor Knives: 42 pcs
- Stationary Knives: 4 pcs
- Knife Material: Cr12MoV
- Motor Power: 45-55 kW
- Hydraulic Power: 4 kW
- Shaft Speed: 80 rpm
- Rotor diameter: 400 mm
- Capacity: 700-1000 kg/h

Knives:

- Tempered steel type Cr12MoV for stationary and rotor knives.
- Heat-treated to 60 HRC.
- All surfaces are precision grounded.

Control System:

- PLC control

Dimensions:

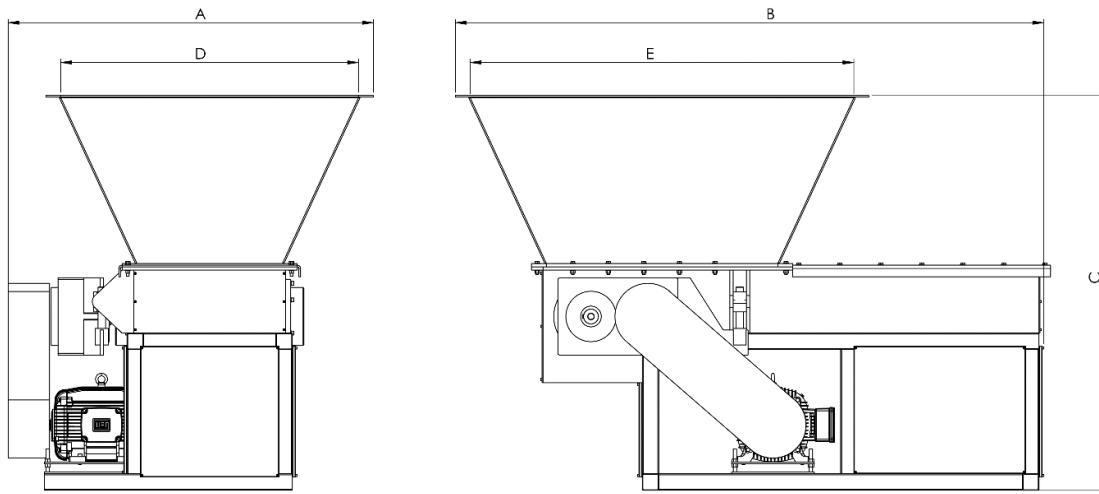

A	B	C	D	E	weight
2600 mm	2900 mm	2100 mm	1400 mm	1400 mm	4000 kg