

TECHNICAL SPECIFICATIONS

Movable Granulator ZM5



General characteristics:

- Type: ZM5
- Crushing Chamber: 510x290 mm
- Rotor Knives: 15 pcs
- Stationary Knives: 2 pcs
- Knife Material: Cr12MoV
- Motor Power: 11 kW
- Rotor Diameter: 290 mm
- Capacity: 180-250 kg/h
- Chamber Opening: Manual

Knives:

- Tempered steel type Cr12MoV for stationary and rotor knives.
- Heat-treated to 60 HRC.
- All surfaces are precision grounded.

Dimensions:

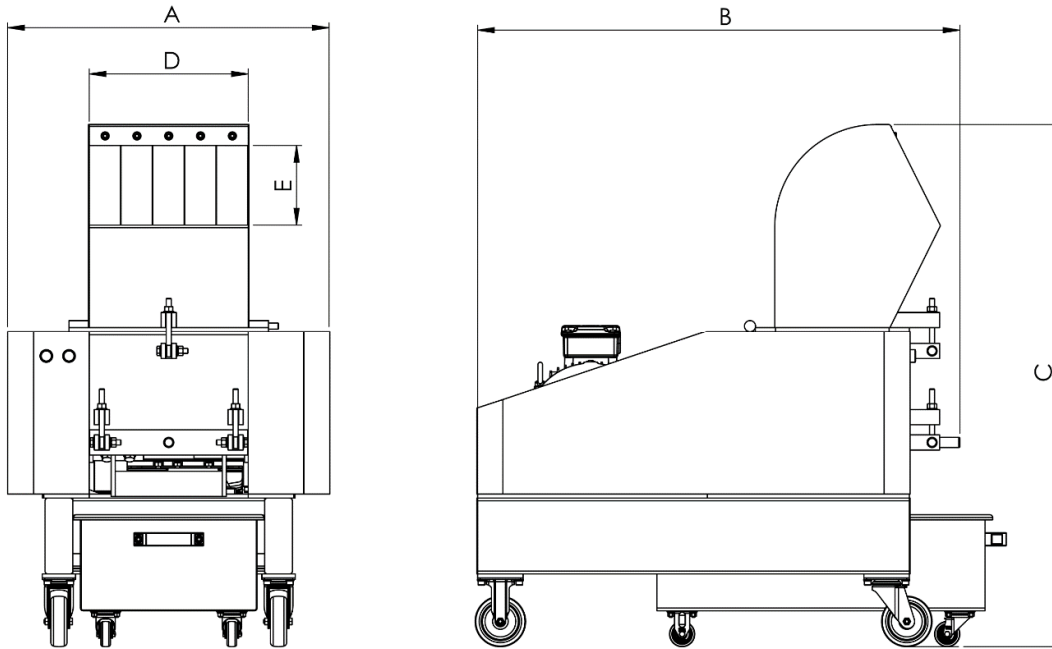

A	B	C	D	E	weight
1000 mm	1510 mm	1560 mm	510 mm	290 mm	860 kg