

TECHNICAL SPECIFICATIONS

Movable Granulator ZM1



General characteristics:

- Type: ZM1
- Crushing Chamber: 180x150 mm
- Rotor Knives: 6 pcs
- Stationary Knives: 2 pcs
- Knife Material: Cr12MoV
- Motor Power: 2.2 kW
- Rotor Diameter: 150 mm
- Capacity: 50-80 kg/h
- Chamber Opening: Manual

Knives:

- Tempered steel type Cr12MoV for stationary and rotor knives.
- Heat-treated to 60 HRC.
- All surfaces are precision grounded.

Dimensions:

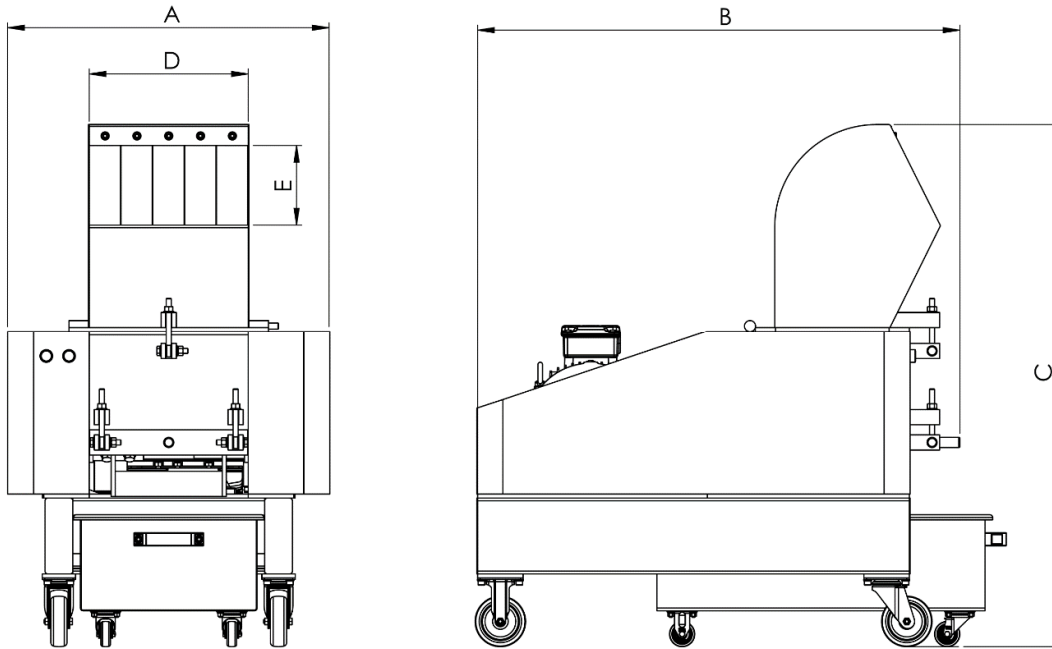

A	B	C	D	E	weight
440 mm	730 mm	800 mm	180 mm	150 mm	140 kg